

NFA 1000

NFA 400

**3D Low Frequency
Analyzer
with Data Logger**



NFAsoft

**Analysis and
Configuration
Software**



Operating Manual

Version 7.2

Thank you!

We thank you for the confidence you have shown by buying this product. It allows for a professional analysis of AC electric and AC magnetic fields according to internationally recognized guidelines and the recommendations of the building biology.

In addition to this manual you can watch the **tutorial videos** on our channel on [youtube.com](https://www.youtube.com) concerning the use of this meter.

Please note:

The only significant difference between the NFA 1000 and the NFA 400 in this manual is the fact that the NFA 1000 allows a three-dimensional potentialfree measurement of the E-field, while the NFA 400 can only be used for one-dimensional potentialfree measurements of the E-field. This distinction is specified in detail in the relevant chapters.

Contents

1	Quick Start Guide	2
2	NFA 1000 Front Cover	3
3	LEDs / Display / Audio Signals	4
4	Switches / Push-Buttons / Connectors	7
5	How to Measure and Data-Log	13
6	Power Supply	15
7	„NFAsoft“	17
8	Firmware-Update	24
9	What if... (FAQ)	25

This manual is based on the firmware version 67 and NFAsoft version 169.

The firmware and software of the NFA will be continuously improved and made available via e-mail or download from our homepage.

Features not yet implemented, but under development, are printed in GREY in this manual.

1 Quick Start Guide

The instructions below refer to the factory default settings. These settings can easily be customized with the help of the supplied software „NFAsoft“.

When you switch on the instrument the LCD will briefly show “batt” and the remaining operation time with the current capacity of the batteries (you may need to switch off the NFA after a couple of minutes and on again in order to update the information).

Set all switches to their top position! (Auto, tRMS, M3D and On)

With these settings and the mode button, one can quickly and easily begin the conventional measurement process, without detailed knowledge of the instrument's features.

The LCD display will now indicate the isotropic (3D) AC **magnetic field** strength as the primary measurement. The coloured frequency LEDs above the LCD display show the active frequencies, the red LED indicating the dominant one. The dominant axis x, y or z is indicated by a red LED on the right of the LCD display. That's it – no further switches or steps needed.

NFA 1000:

To measure the **E-field with ground-reference** (1D) simply connect the grounding cable. The NFA detects the attached cable and automatically shows the corresponding AC electric field strengths and frequencies. The E-field measurement will now be displayed as the primary measurement and the 3D magnetic field as the secondary. By depressing the ‘mode’ button you can easily switch from this to the 3D magnetic field on the display.

To measure the **three dimensional potential-free AC electric field**, switch to **E3D** and fix the instrument onto a potential-free rod or onto a support. By pressing the ‘mode’ button you can easily switch from this to the Z-axis of the AC magnetic field on the display.

NFA 400:

For an E-field measurement, simply switch to **Ey**. You now have two possibilities:

- If the grounding cable is plugged in and connected to the ground potential, you are measuring “against ground”.
- If you attach the meter to a potentialfree rod or place it onto a support, you are measuring “potential free”.

Press the ‘mode’ button to switch from this to the 3D magnetic field on the display.

Should the meter not do what you expect, please turn to the chapter on FAQs (frequently asked questions) at the end of this manual (Chapter 9)!

Note: For potential-free e-field-measurements the highest accuracy will be reached when used without the yellow silicone holster.

2 Front Cover NFA 1000 and NFA 400

Analogous front cover for NFA 1000 and NFA 400

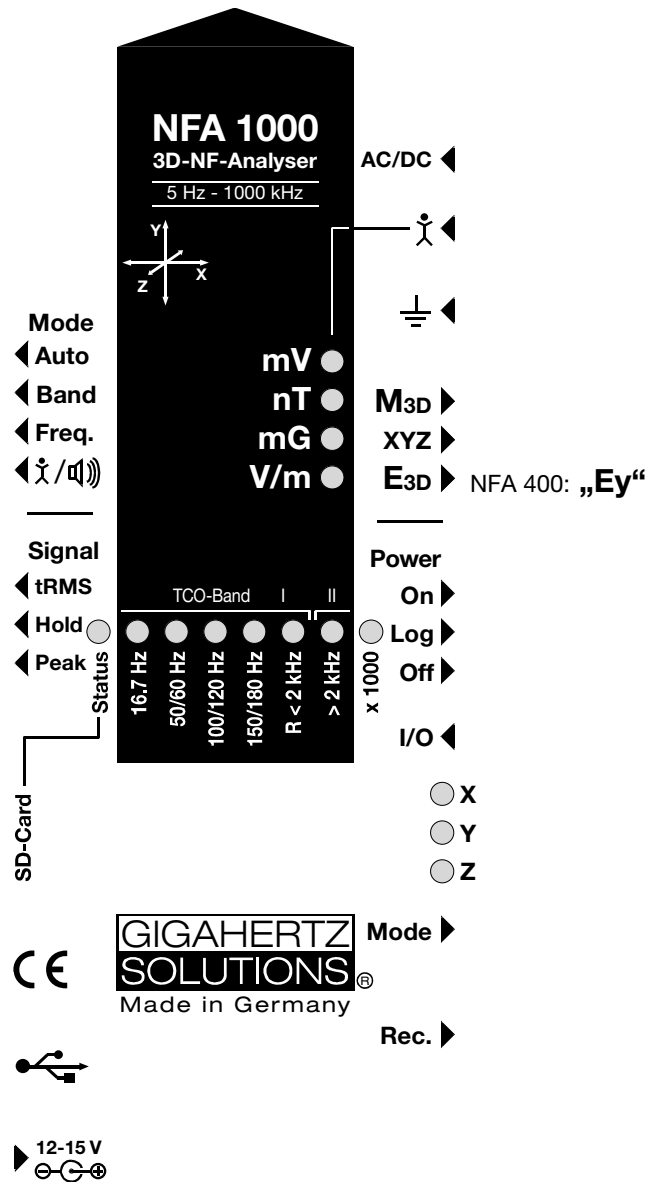

3 LEDs / Display / Audio Signals

3.1 LEDs and Display

The measured value shown on the display...



...is the unit adjacent to the solid green LED (primary measurement).

A flashing LED indicates the unit of the secondary measurement, which can be selected by depressing the “Mode>” button.

In fields of very high magnetic intensity, the value will be displayed in μT (microTesla), indicated by the red LED “X 1000”. Also the green LED will then turn red indicating a change of scale. Both LEDs will start flashing red when the measured values are higher than the instrument can display. Similarly, when measuring body voltage, a change from mV to V for higher values is indicated.

Special LCD Display Messages

“**Low Batt**“: The rechargeable battery is low – please charge the battery

“**Err.**“: Short for ‘Error’. Indicates an erroneous configuration. This can occur when a grounding cable or mains adaptor is connected and potential-free E-field measurement is selected. Select a different setting!

„----“: Instrument is in the process of determining the measurement, or the value is too small to be measured.

„**CHAR**“: Instrument is being charged.

(For technical reasons “FULL” will be shown shortly before this, which is to be ignored)

„**FULL**“: During the charging process, with the mains adaptor connected, this indication means: charging process completed, battery loaded. During normal operation, however, “FULL” means the SD memory card is full.

„**nbAt**“: The processor cannot recognize the battery (see the note below)

The Time indications are set up as follows:

„**XXXd**“: XXX days or

„**Xd.XX**“: X days and XX hours or

„**XX.XX**“: XX hours and XX minutes.

„**XX.XX**“: (with blinking dot): XX minutes und XX seconds.

Elapsed time will be shown when switching on and while logging.

Please note: when switched on, the NFA will normally show the remaining battery life. However certain events may cause wrong times, “00:00” or “nbAt” to be displayed. In that case please leave the meter switched on for a few minutes to perform its calibration algorithm, then switch off and back on to display the updated battery life for the “Log” mode. If case the false readings persist, please check chapter 9 for further information.

Status LED

The “Status” LED indicates the current mode of operation

“Red” means “instrument is being charged”.

“Yellow” means “measurement in progress, NO recording”.

“Green” means “measurement in progress WITH recording”,

Note: with the switch set to “Log.”, the “Status”-LED is switched off after a short while, in order to extend battery life.

LEDs to indicate the applicable frequency bands:

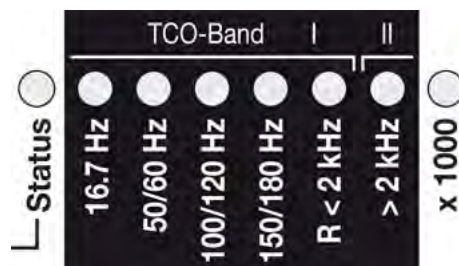

The frequency-LEDs change their colour in proportion to their contribution to the total field strength. See below for details on LED display modes.

”16.7 Hz“: In use for railway lines in some European countries. The reading also includes the 2nd harmonic.

”50/60 Hz“¹: Mains frequency. The bandwidth only covers individual frequencies of 50 Hz and 60 Hz with their respective lock-in ranges.

”100/120 Hz“¹: This LED indicates the contribution of the second through fourth “even” harmonics. The strongest frequency can be numerically displayed when using “Freq” mode.

”150/180 Hz“¹: This LED indicates the contribution of the third through fourth “uneven” harmonics. The third harmonics will presently be found in many homes and most offices as a significant portion of the total measurement. The frequency of the strongest source can be numerically displayed when using “Freq”.

”R < 2kHz“: Means “Remainder of frequencies below 2 kHz”.

This LED does not show the whole band, but only the sum of all frequencies below 2 kHz which are not covered by the LEDs on the left.

”> 2kHz“: Comprises frequencies within the upper TCO-band of 2 kHz up to 1 MHz.

“x 1000”-LED

Turns red when the measurement scale increases.

¹ The NFA automatically detects the mains frequency and adjusts the indication of its harmonics. With “Freq.” the actual mains frequency can be determined exactly. The LED’s for 16.7 Hz, mains frequency and its harmonics up to 2 kHz have a suitable lock-in range to cover mains fluctuations.

There are **two display modes for the frequency-LEDs**:

“Simple/Steady“: (= preset)²

The red LED represents the strongest frequency, and the yellow LED the second strongest. The green LEDs indicate the total frequency range in the current setting.

“Full Information/Volatile“: This makes the LEDs rather unsteady/volatile. (To be configured with NFAsoft)

The proportion of the respective frequency band in relation to the total signal is being displayed. These proportions are shown as follows³:

RED	= DOMINANT (> 50%)
YELLOW	= MEDIUM (< 50%)
GREEN	= SMALL (< 10%)

3.2 Audio Signal

The acoustic signal is always linked to the respective measured value and has a „Geiger Counter“ characteristic, i. e. an increasing signal intensity will in turn cause an accelerated rattling sound.

If the “Mode”-switch is set to „“, press the ‘Mode >’ button to turn the volume up and the ‘Rec. >’ button to turn the volume down (and finally: off), as long as no grounding cable is connected to the instrument.

Please note: For extra-precise measurement requirements turn the acoustic signal volume down or even switch it off completely.

² In order to allow for less fluctuations in this mode an internal high pass filter is switched on. With NFAsoft it can be configured to 16.7 and 50 Hz. Experience has shown that the best combination for a freehand measurement is a filter set to 16.7 Hz for magnetic fields and to 50 Hz for electric fields. Electric fields of the 16.7 Hz railway line power frequency (in some European countries) are quite rare indoors and can still be evaluated in the “band” mode. They can still be separately evaluated with NFAsoft.

³ To make it more ergonomic for the user, frequencies below the nominal display resolution (that is < 0.1 V/m or < 1 nT) are not indicated by an LED-signal but will still be recorded down to the noise level. Hysteresis: 9/12% resp. 45/50%.

4 Switches / Push-Buttons / Connectors

4.1 On / Off switch (“Power“)

“On” = Standard Measurement Setting

LEDs and acoustic signal remain activated for manual measurements when you switch to “Log” until the Status-LED is lit green, logging continues even when you switch back to “On”.

“Log” = Logging / long term recording

All LEDs and the acoustic signal are deactivated to save battery life during data logging.

“Off” = Device is off

4.2 Field Selection for 3D Measurement

M3D = Magnetic field measurement (3D)

The isotropic point or magnetic field sensors are below the coordinate system printed on the meter faceplate. The dominating axis is indicated by a red LED next to the display.



XYZ = Axis indication

Here, the NFA 1000 will show either the magnetic or the electric field in its three individual components depending on the field type from which the switch was set to “XYZ”, whereas the NFA 400 will only show the individual components of the magnetic field. Press the ‘Mode >’ button to switch from one axis to the other. Please see chapter 4.9 for details to this or to the automated scrolling.

$E_{3D(NFA1000)} / E_{y(NFA400)}$ = Potential-free E-field measurement

The field sensor pairs for the X-, Y- and Z-axis (directions correspond to the imprint) are situated within the meter close to the housing. For a proper measurement the meter has to be set up more than 12 inches away from any metal objects on an insulated “holder” (accessory PM1) or held with an insulated rod (mounting aid PM5s). Also cables or probes must not be connected during this measurement setting. In the case of an erroneous configuration, the display will indicate “Err.” until the configuration is corrected or the setting is changed to magnetic field measurement. The

measuring person should avoid hectic movements and keep a distance of at least 1.5 m to the object of measurement.

For E-field measurements against earth potential, please plug in the grounding cable and

- switch to "M3D" (automatic adjustment) on the NFA 1000
- switch to "Ey" on the NFA 400.

4.3 Sockets for Inputs and Grounding

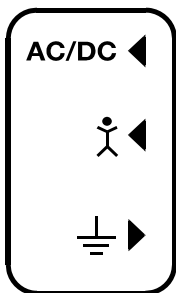

AC/DC = Combined AC/DC-Input

The moment you connect an external sensor, its signal will automatically be displayed in mV and logged if required. When Recording, make sure the "Mode" switch is set to "Auto". This input is protected from overvoltage conditions for both AC and DC sources.

- **AC:** A displayed value of 2000 corresponds to an AC signal of "1V_{peak to peak}". The AC portion is still under development⁴.
- **DC:** It can linearly display and log signals from +/- 0.1 to +/- 1500mV, i.e. with an HF59B connected and set to coarse (adjust to 1V), the values recorded will be between 1µW/m² and approx. 30,000 W/m². The value will be displayed in mV⁵.

For logging high frequencies please make sure to remember the settings of the connected HF-Analyser, as they will not be registered by the NFA. You may use the audio note feature for that.

This input can also be used for the connection of an optionally available magneto-static and electrostatic sensor.

= Input socket for body voltage hand probe

Input for the connection of a hand probe for the measurement of body voltage in mV. The connector is a 4 mm banana jack. For displaying and recording, set the "Mode"-switch to  and plug in the grounding cable.

This is the only input which cannot be recognized automatically (being single-pole).

= Socket for the grounding cable

Allows the connection of a grounding cable for an E-field measurement with reference to ground (in compliance with TCO). This will be detected automatically by the instrument and the display will change to E-field with reference to ground correspondingly.

⁴ Note: The AC-functionality is not yet been fully qualified and is presented as is. The information produced by the frequency decomposition of a demodulated pulsed HF signal will, of course, not provide any useful data.

⁵ For all measurement ranges, even when using an attenuator or amplifier, NFAsoft offers a comfortable conversion tool. The random noise will make it impossible to properly display or record measurement values below 0.1µW/m², though.

Socket for the TCO-conformed probe at the front end of the meter

This is for the TCO-conformed probe available as an optional accessory from Gigahertz Solutions.

4.4 Mode = Selection of Measurement Mode

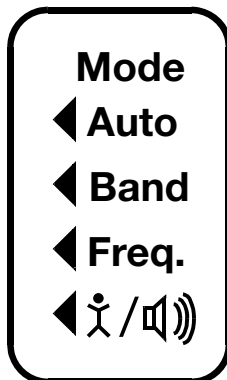

Selects all measurement and display options of the instrument with the field selector switch and the “Mode >” button. Configuration errors will be detected and indicated by “Err.” on the display until resolved.

When set to **◀ Auto** the NFA recognizes probes connected to it, and shows the corresponding values. If there is no external probe connected to the instrument, it will show the selected 3D field type. By pressing the mode button, you can “toggle” between the primary and secondary display measurements. The secondary measurement field is indicated by a short flashing of the corresponding unit-LED.

◀ Band and ◀ Freq. = Display of the individual frequency bands resp. the exact frequency of the frequency bands⁶

Selection of the individual frequency bands is possible by clicking the “Mode” button⁷. Please see chapter 4.9 for more details on this feature or on automated scrolling.

◀ ⚡ / 🔊 = Capacitive body coupling / volume

In this setting, the display will show the signal generated by connecting a hand probe. The grounding cable needs to be connected in order to assure proper measurements. For volume regulation please see chapter 3.3.

⁶ An exact frequency indication is only possible up to 30 kHz.

⁷ If the 50 Hz high pass filter has been set with the help of the configuration part of the NFAsoft (maybe even as pre-setting), the 16.7 Hz LED will remain unlit. However, the filter only applies to the display in the “Auto”-mode and to loggings in the “All3D”-channel. The aim is to tranquilize the display. Nevertheless, possible frequency components up to 16.7 Hz can be displayed by using “Band” and “Freq.”.

4.5 Evaluation of Signal

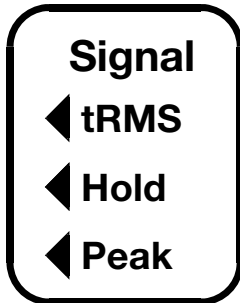

◀ **tRMS = true RMS value**

tRMS = “true Root Mean Square”. The values displayed and recorded can be compared directly to classifications recommended by building biologists.

This is the correct standard setting of the NFA, even for logging the peak values of a connected HF-Analyser.

◀ **peak = Peak value**

Real peak value measurement: With this setting the meter measures the highest culminating point of the wave⁸. A new, still experimental measurement feature for building biologists which allows for a more detailed analysis of the LF world in a way which has long since been considered essential in the analysis of high frequencies. This option supplies important information for the evaluation of “Dirty Power” (E-field > 2 kHz).

◀ **Hold = retain maximum value**

Retains „tRMS“ or „Peak“ of the signal, depending on the switch position from which „Hold“ was chosen. When the signal switch is set to „Hold“ only the reading on the display is held, the real time value will still be recorded onto the SD card, if recording.

4.6 SD Memory Card

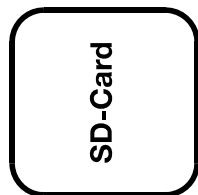

This is the slot for the SD card. To prevent it from being ejected inadvertently slide it in beyond the external surface of the casing until it snaps (use fingernail or pencil, if necessary). To extract it press again to undo the snap mechanism.

The high-speed SD memory card (4 GB, SDHC) supplied with the instrument contains the current version of the NFAssoft software and enough memory for several 36h recordings. Important: Please make sure to only use SANDISK cards! We have had a lot of bad experiences with other manufacturers.

Your PC will recognize the SD card as an external device when connected by USB cable or slid into a card reading device. It can then be processed with the standard functionality of your operating system. By inserting the SD memory card directly into

⁸ The resolution of the frequencies during the analysis of the (actually by their nature broadbanded) peak values does not consider phase information that is being a worst-case consideration. Tolerances are much higher than using the tRMS analysis. It cannot be used with the floating potential E-field measurement for the time being.

a card reader of the PC, data transfer will be 40 times faster than by using the USB cable⁹.

Please note: Do not remove the SD memory card while the NFA is running!

4.7 USB-Socket

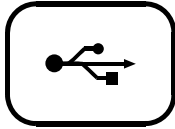

USB 1.0 computer interface connection: Used for meter configuration with NFAsoft. Please take care to have the NFA switched off when connecting or disconnecting the USB-cable! Please note: for the time being the USB connection works for windows and Linux only!

4.8 Charging Socket

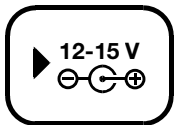

For the connection of external DC sources:

External supply: 12 V battery or 12 V DC power supply unit is sufficient to keep the instrument operational for long term data logging, but will not recharge the battery.

Charging: 15 to 18 V DC battery or AC adaptor is required to charge the instrument. Measurements or recordings parallel to the charging procedure are technically possible, but not specified, therefore not to be recommended.

4.9 „Mode“ and „Rec.“ - Buttons for Navigation and Voice Recording

In connection with the “Mode”-switch and the switch for selecting the field type, the “Mode” and “Rec.” keys form part of the many special functions of this device.

They are not needed for a simple measurement of the 3D magnetic field.

“Mode” = Change of display mode or “Step ahead”

The configuration of the “Mode”-button is context sensitive.

⁹ In order to make use of this speed advantage, your SD card reader needs to be specified „SDHC“ which is standard for units built 2008 or later. For older units inexpensive adaptors are available. The SD-card reader is included in the scope of supply of the NFA 1000 only.

If the “Mode”-button on the left is on “**Auto**”, the NFA recognizes external probes connected to it, and displays their corresponding values. If a probe is not connected to the instrument, it displays the selected (“primary”) field type.

- Press and release the “Mode>” button to switch from the primary to secondary measurement fields. The secondary or background measurement field is indicated by a quick flashing LED corresponding to the unit-LED.

If the “Mode”-button on the left is on “**Band**” or “**Freq.**”,

- Press and release the “Mode>” button to select the next frequency band (indicated by the corresponding LEDs), and also the axis per band in the “XYZ” mode.
- Press and release the “Mode>” and “Rec>” buttons at the same time to display the individual axis one after the other in an infinite loop until one of the buttons is pressed again.

“Rec” = Record an audio note

Keep this button pressed and so activate the internal microphone to accept your live comments. The microphone is positioned above the “Rec.” button (marked by the hole in the casing lid). It is sufficiently sensitive to pick up audio comments from a few metres distance.

While the “Rec.” button is pressed for taking your notes, these will be recorded in a standard WAV file parallelly to logging value recordings. These audio notes will then be directly allocated by NFAssoft to the corresponding recording times in the graphic.

4.10 I/O - Microphone / Headset

Allows the connection of a mono headset for dictating or listening to the audio analysis.

5 How to Measure and Data-Log

5.1 “Live”-Measurement

Of course the meter can be used the “conventional” way: simply switch it on, set the required measurement parameters, and read the values recorded. When operating in the conventional mode, the “Status-LED” will be yellow.

In addition, the device is capable of logging all settings as well as the measurement values of all four channels at once (i.e. the three field axis values plus one additional channel). This data is stored onto an SD-card for future analysis. This function can be activated by temporarily switching the “Power” switch to “Log.” until the status LED turns yellow. Then switch the “Power” switch back to “On”. Please note: When logging with the power switch set to ”LOG” and changing the field of measurement and recording (for instance from M3D to E3D), this will cause the recording session to be closed and a new log file to be created.

These recordings can be annotated by real-time audio recordings which will be assigned automatically to the respective measurement for replay.

The following chapters 5.2 and 5.3 are only relevant for the NFA 1000.

5.2 Guided 9 Point Measurement of Sleeping Areas

For alternating electric fields, the guidelines issued by the VDB e.V., Germany, require a detailed analysis of the floating potential electrical field in sleeping areas, specifying nine points (three each in the head-, torso- and foot area, with the outer edge of the instrument located 10 cm off the bed’s edge). The NFA in combination with NFAsoft allows for a “guided measurement” in order to efficiently accomplish data collection and evaluation.

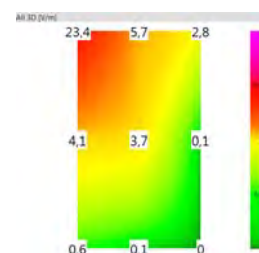

Preparation and start of the measurement:

- Use a potential-free rod (mounting aid PM5s) or the holder PM1 (stabilized by, for instance, a stiff piece of cardboard or a plywood panel).
- Switch the “Power”-button to “On” and choose “E3D”, “Auto” and “tRMS” (choose M3D for magnetic fields).
- Press the “Mode”-button until 9Pt is indicated on the LCD and then let go. A beep will indicate the activation of the 9 point measurement.

The NFA guides the user through the nine points by means of short audio signals (“beeps”). These nine points shall always be processed in the same order, head area: left, middle, right, followed by torso area: left, middle, right and finally feet area: left, middle, right.

- The beeps are not time controlled but the NFA will adjust itself to your personal work rhythm by “sensing” whether it is being moved or it is lying still¹⁰. This way you can finish the nine point measurement within less than a minute or – if you prefer to take it a bit slower – you need not let yourself “be rushed through the measurement by the beeps”.
- The algorithm is as follows: after the activation (see above) the NFA “waits patiently” to be moved (... that is being moved to the first measurement position: top left) and it will not beep to confirm the next measurement before the instrument has been left still in that position for a couple of seconds¹¹ (... in order to pick up a valid measurement). After the beep – *and in your speed* – you can proceed to the next measurement position¹².
- **PLEASE NOTE:** In order to support this algorithm move the NFA more or less rapidly from one measurement position to the next, and “bump” it onto the bed’s surface with a little impact in order to give the transition movement a clear end¹³.
- For an analysis of the collected data use NFAsoft.

5.3 Guided 6-Point-Measurement of Working Places

The NFA and the NFAsoft also support the measurement of working places. In this case six measuring positions are to be collected, as shown in the drawing. For a selection of the working place measurement on the NFA keep the “Mode” button pressed until “6Pt” is displayed on the LCD. For the further procedure follow the instructions of the 9-Point-Measurement in the order: head, elbow, bottom, hands, knees, feet.

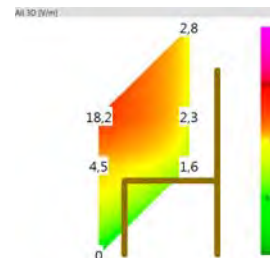

5.4 Long Term Data Logging

The normal approach in building biology is to record only the AC magnetic field as tRMS. Recording the E-field usually gives little additional insight but often causes confusion.

¹⁰ The interval from beep to beep can vary between 3 and up to 20 seconds according to your work rhythm and movement pattern.

¹¹ This time delay is user-definable with NFAsoft.

¹² After the beep the NFA will wait up to 20 seconds for a movement

¹³ This way the NFA can distinguish more reliably whether it is in motion or kept still. If you use a potential-free rod then try not to move the instrument after you have “hit” the measurement point, if you use a holder then withdraw quickly to a minimum distance of 1.5 m and keep still there in order to avoid movement-induced “pseudo-fields”.

Recording the E-field leads to little or no additional insight but often returns confusing or meaningless results. Recording E-fields with external power supply is completely senseless for obvious reasons.

The interval for recording data is set to 10 data sets/sec.

Initiating Long Term Logging of the Meter

For a long-term recording of several hours or days, set the “Power” switch to “Log”. (The status LED will turn green and long-term recording will start off after a few seconds. In this mode the LEDs and the sound are turned off to extend the battery life, after a while also the green status LED.). The display will show the logfile number (“L...”), the elapsed time of recording as well as the remaining time of use in an infinite loop until the battery is empty or the SD-card full. For information on the display format please see chapter 3.1. When switching back to “On”, recording will be continued without interruption.

The instrument records all data corresponding to its field selection switch. The fourth channel will automatically record the E-field if the field selection switch is set to M3D and the AC/DC socket is not connected. However, if an HF analyzer is connected to the AC/DC socket, it will automatically record the output of this external device.

“Locking” of the Instrument

“Locking” ensures that the instrument exclusively executes the predefined tasks when left at the customer's place for long-term recordings. To lock, remove the SD memory card from the instrument after predefining the measurement settings, set the micro switch on the top left of the SD-card to “lock” or “write protect” and reinsert it. Note: The data will still be recorded!

IMPORTANT: Don't forget to “unlock” the SD memory card finishing a “locked” long term recording!

6 Power Supply

6.1 Internal Rechargeable Battery

The instrument features high performance Lithium Ion rechargeable batteries (2 x 3.7 V). When fully charged, they will last for up to 36 hours of data logging¹⁴.

A vital factor for the durability of Lithium Ion rechargeable batteries is to absolutely avoid a deep discharge. The NFA setting will prevent a deep discharge in operation, however, in view of the inevitable self-discharge, the meter should not be kept with “almost empty” batteries for longer than a few weeks only.

¹⁴ Please note that Li-Ion batteries, even when treated with care, will lose some of their original capacity within one or two years and their typical life expectancy is 250-500 complete charge cycles. In this case please always replace both batteries. Please see chapter 9 for information on the initialization of the capacity display.

6.2 Charging

To charge the batteries use the **15 V** AC adaptor. If the device is switched off while charging, the display will show “CHAR” and the potential runtime of the instrument with the current capacity status in an infinite loop. Measurements or recordings during the charging process are technically possible, but not recommendable.

Thanks to a sophisticated algorithm, the NFA charging process will start off extremely quickly, but will slow down towards the end in order to achieve maximum loading capacity. Due to the large variation in the Lithium Ion batteries supplied by their manufacturer, the maximum capacity as well as the charging time are subject to fluctuations. The specified battery running time is mostly reached after a charging period of approx. 8-12 hours. A (significantly) longer charging period, as well as a recalibration of the capacity display (see Chapter 9) may considerably extend the battery running time. The capacity display can only be taken as an estimate. Reliable information can be obtained by logging until auto-power-off and subsequent verification with NFAsoft.

6.3 External Power Supply

For logging with external power supply use the 12 V AC adaptor. After a logging time of more than the typical 24 to 48 hours the probability of an unwanted shut-down due to unexpected operating situations increases significantly. Longer logging times can therefore not be guaranteed.

Recording E-fields with an AC adapter connected results in meaningless data.

Longterm recordings of the 3D magnetic field and the AC entry can also be done using external power from an AC adapter. In this case, the adapter should be placed as far as possible from the instrument and turned in such a way that the resulting magnetic field is as low as possible, as it can influence the readings.¹⁵

6.4 Battery Change

For safety reasons, please only use original battery packs classified by us (integrated protection circuit). The two battery cells fit tightly, but can easily be removed for the purpose of battery change. In no case untighten the screws of the meter! Putting the meter together is very complicated, and therefore subject to a fee if it needs to be done by one of our technicians.

¹⁵ To determine the emission created by the AC adapter at the location of the NFA, proceed as follows:

- Place the instrument and adaptor into their measurement location
- Plug the AC adapter into the wall and to the NFA. Wait until the readings on the display stabilize.
- Disconnect the adapter from the NFA without changing its position and orientation; wait for the display to stabilize.



This procedure will also be logged, and should be marked with an audio note. This will be accessible when evaluating the logged data on the PC. Now potential disturbances can be noted on each axis and corrections be made, if necessary.

7 „NFAsoft“

The provided software allows...

- for the analysis of the data logged by the NFA
- for the configuration of the NFA according to your preferences and habits.



A double-click on the program-icon  opens the window shown on the left. Here you can chose between the tool for the analysis of the data  and the tool for the user-specific configuration of your NFA  .

The software is subject to continuous upgrade. The most current revision can always be found for download on our homepage.

System requirements

NFAsoft is made for Windows (98 and up higher). Linux and Mac versions are provided “as is”. **NFAsoft requires no installation** – just double-click and start!

In some cases, it might be necessary to temporarily disable your anti-virus software. Anti-virus software may interpret NFAsoft as a threat and hence might disable or even erase it. It may be necessary to repeat this upon loading an upgraded version of NFAsoft. NFAsoft can be loaded and executed directly from the SD memory card through a card reader or through the USB interface cable. The NFA is supplied with a “Class 6 SDHC”-SD memory card (appropriate readers have been available since 2008, adapters are available for older computers).



7.1 Data Analysis: File Types

A click on the button  opens the program and a Windows-box for file selection. The following file types are available (the consecutive numbering is independent from the file type)

- LOG00001.**TXT** log file (long time recording)
- LOG00002.**9PM** 9-Point-Measurement (sleeping area)
- LOG00003.**6PM** 6-Point-Measurement (workplace)
- REC00004.**WAV** audio file (recorded note).

7.2 Data Analysis: Longterm Recordings

Double-click the appropriate log file for analysis. For longterm recordings the following window will open (check chapter 7.2 for 9 point measurements):



- The far left column labelled “Channels“ displays statistic evaluations of the plot on the right (in real-time)
- The large area on the right shows the plot of the collected data over time.
- The “x” (horizontal) axis of the plotted data is the time scale and the “y” (vertical) axis shows the units of measurement corresponding to the field of measurement.

Plotted Data Window

Units of measurement appear on the corresponding channel window on the left and are not indicated on the y-axis. The different plots are colour coded. This allows for different channels to be shown simultaneously.

The x-axis indicates the time span. The figures at the left and the right end of the grey status line show the times of start and end of the logging period.

If the status line is mouse clicked, the window on the right will appear. Here one can enter a preferred time span to view. The time span can also be selected in the “View” menu.



The colouring scheme of the plot corresponds to the standards for building biology measurements (SBM2015): Green for “no concern”. Yellow for “slight concern”. Red for “severe concern”. Purple for “extreme concern”.

If one selects two channels with different units, the SBM colour scheme of the plot’s background will be the one corresponding to the unit of the selected (= bold) channel. It will be bold for the one and regular for the other, equalling the markings in the “Statistics/Channels” window.

Navigation within the Plotted Data

Within the plotted data you can easily navigate using a mouse and its scroll wheel. Move the mouse pointer into the data plot. The scale of the x-axis will be

- zoomed in when scrolling up or by using the “Up Arrow”, zoomed out when scrolling down or by using the “Down Arrow”
- centered around the clock time indicated by the position of the mouse

The data area can be repositioned on the x-axis by a left mouse click hold and drag left or right. You may just as well use the “right” and “left” arrows of the keyboard. Zooming of the time on the x-axis is also possible via the “View” menu.

Scaling of the y-axis is done automatically by default but can be adjusted manually if desired through the “View” menu under “Y-Scale”. You can also adapt the scaling of the y-axis manually via the menu (under “View / Scale”).

Listening to the Audio Notes

Audio notes dictated during measurement or longterm recordings are shown in the diagram directly at the corresponding point of dictation. Simply click on them in order to listen to the information recorded. The audio notes will be played back by the audio player of your computer. The grey bar on the top will show the file name and a level preview.

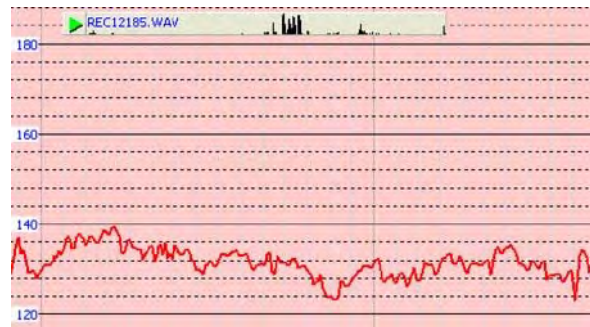

A display of the audio files (.wav) within the diagram is only possible if they are stored in the same folder as the LOG-file and if they are not renamed.

Insert Comments directly into the Diagram

Areas of special interest can be commented directly in the plotted data. Simply position your mouse where you need it, right click and enter your comments in the comment window. When you click Ok, the comment will be embedded into the data, marking an event or section of interest. .

Program Window “Statistics Channels”

To display the data of a particular channel, click the triangle to the left of the channel.

If multiple channels are open, an additional click on the channel information will bold the channel’s plotted data and its statistical data.

The top five values are standard **statistical values**¹⁶. The numerical value “Edges per hour” is used to analyse the number of steeply rising edges, spikes, peaks, pulses, sharp bursts or high frequency transients of the field. The edge thresholds can be defined in the “Channel” menu under “Set edge criteria”. This is an experimental function. PLEASE NOTE: If the 50 Hz high pass filter has been set with the help of the configuration part of NFAssoft (maybe even as pre-setting), this only applies to the channels “All3D”, “AllX”, “AllY”, and “AllZ”. Nevertheless, possible frequency components at 16.7 Hz will also be recorded in the correspondent channel. In this case the sum of the frequency specific channels may well be higher than that of “All3D”.

¹⁶ The 95th percentile is calculated heuristically. If the possible deviation exceeds 10%, it will be noted in parenthesis after the figure in absolute terms.

The light-blue field underneath the statistical channel data represents the frequency distribution of the measured intensities of the specific channel („Histogram“). It is self-scaling and can be interpreted as follows:

- On the left side of the x-axis a formula calculates and plots how often the minimum value has occurred in a given time interval, and similarly on the right side for the maximum value.
- The higher point marks the measured intensity - found most often. The lower points indicate a specific value very seldomly measured.

Menu

Edit

“Copy all“: Copies the plotted data area as well as the drop-down of the “Statistics/Channels“ section into the buffer – from here it can be inserted directly into your measurement protocol at any point of your choice. This is similar to a screen shot.

All other edit options are self explanatory.

View

“Edge Display”

Choose the menu option “View/Edge Display” to activate the edge display. The edge display option will help find important field strength fluctuations. Steep edges are marked in the diagram in the colour corresponding to each channel – the marked channel will be bolded, the others won’t. This way you will always have an overview of what’s going on in the other channels, even if your focal point is, for instance, the 3D-value. The threshold value for an edge display can be defined in the menu option “Channel/Set edge criteria”.

“Set Times”

Choose the “Set Times“ option to scale the graphic to a defined time segment.

“Y-Scale“

- Automatic – The y-axis will be scaled automatically to give the best display of the area selected for analysis.
- Manual – The y-axis scaling can be manually controlled in this mode. Allows for and will assist in analyzing small values (e.g. those over 2 kHz) overshadowed by other very strong field intensities.

“All” – zooms out the x-axis and displays the complete data set on the data plot. The keyboard “A” keys can alternatively be used.

Use the arrow keys to take over the functions of the mouse.

Channel

Set Edge Criteria (experimental!)

This feature is new and its intention is to facilitate professionals the discussion and analysis of “dirty electricity” beyond today’s definition. Activate “Edge Display” in the menu option “View” to use this function.

This function allows you to define a threshold value with which a spike can be marked directly in the “Edge Display” of the plot. This threshold can be selected individually for every channel. Standard values have been pre-selected as defaults.

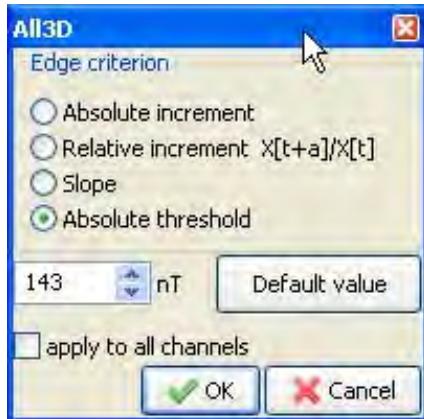

When clicking “Set edge criteria”, the following window will open. Description:

Absolute increment = Marks a rise of the measured field intensity between adjacent points of time by a user defined absolute increment level in V/m, mG or nT

Relative steepness = Marks a rise of the measured field intensity between adjacent points in time by a user defined factor or multiple.

Slope = Marks a rise of the measured field intensity between adjacent points in time by a user defined slope rate in V/m, mG or nT per second. This is independent of the measuring intervals. A hypothetical interval of 1 second would give that increment. This permits to compare results recorded with different recording intervals.

Absolute threshold = Marks a rise of the measured field intensity between adjacent points in time by a user defined threshold level in V/m, mG or nT. Any rise beyond this absolute threshold value will be marked.

The selected edge criteria will be graphically displayed on the top of the plotted data section and will appear numerically in the field channel statistical data section under edges per hour for that particular time span. All edge markings displayed appear in real time and allow for a quick visual analysis.

When clicking the „ok“ button, the selected criteria and the set value will be transferred into the statistical values of the channel. When re-accessing the menu option “Set edge criteria”, the pre-set values will again be displayed (under construction).

Select HF-Unit

This function will only be displayed when selecting „CH 4“ in the „Channels“ window and the data recorded in this channel are those of an external input device such as an HF-Analyser (and are therefore recorded in mV). Upon selection of this point of the menu the following window will open up for a selection of the HF-Analyser settings during the recording period.

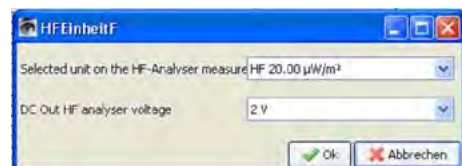

nT <> mG

This function allows to subsequently convert a chosen channel’s data from milli-Gauss to nanoTesla and vice versa.

Convert Units

This function can be used to display whichever values recorded via the AC/DC input port directly in its original unit. This way, an HF-recording can be shown either in $\mu\text{W}/\text{m}^2$ or V/m . A new channel will automatically be generated, thus avoiding any potential loss of data.

More help to be provided in future revisions.

Rename or Delete Channel

Allows for a renaming or deleting of the marked channel.

Summarise Channels

The plotted channels (selected on the left) will be added up (“square sum”) and added as a new channel. The sum of 100/120 Hz, 150/180 Hz, $R < 2\text{kHz}$ and $> 2\text{kHz}$ are considered to be the relevant parameters for the evaluation of “dirty electricity”.

Extras

The first two items in the dropdown menu have been explained already.

Create KML-File

Required as a plugin for the connection of GPS-data, NFA logs and Google Earth (currently in its beta phase). Please ask for the current manual by e-mail.

7.3 Data-Analysis: 9-Point-Measurement / 6-Point Measurement

For a graphical illustration of recorded 9-Point-Measurement please double-click the respective file with the extension “.9PM”. The illustration is frequency specific. Please note that the readings of the channels X, Y and Z as well as “All CH4” are dependent on the position of the instrument and that the graphical illustration is for orientation purposes only. “Edit” in the menu offers you the possibility to copy the illustrations into your report, also individually. The evaluation of the 6-Point-Measurement is done analogous to the 9-Point-Measurement.



7.4 User-specific Configuration of the NFA

This part of NFAsoft allows for a customized user definable configuration of the NFA. The configurations will be made available in the “CONFIG.NFA” file of your NFA. The new settings are automatically loaded by the NFA upon its next start when saved on the SD memory card.

Several customized **pre-settings** for NFAsoft can be defined allowing a quick access. Simply select the settings as required and activate the button “save as pre-setting for NFAsoft”. All pre-settings are stored in the file “NFAsoft.ini” and are available for NFAsoft provided that this file is in the same folder.

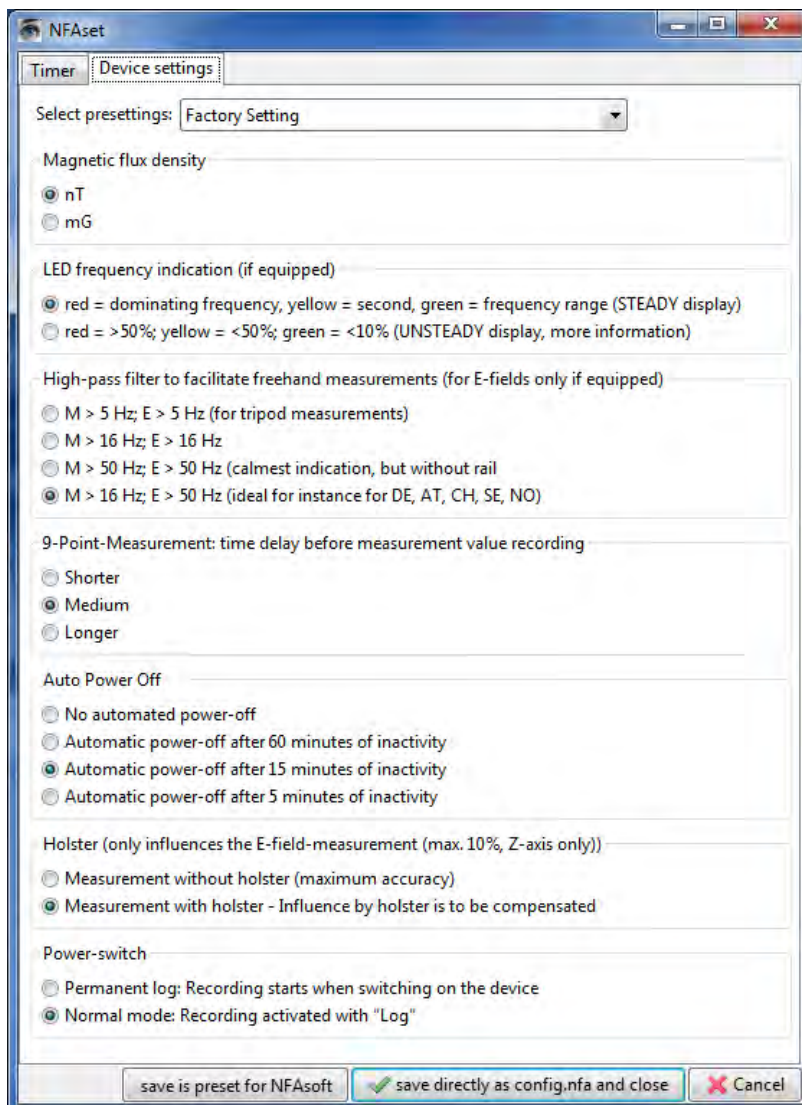

For a **synchronization of the time**, connect the NFA (with SD card!) To the computer with the USB cable. Synchronized station happens automatically, as soon as “CONFIG.NFA” is safe to the SD card.

If the **high pass** is set at **50 Hz**, this only refers to the broad band reading or recording as it reduces the influence of movement induced field components. For full information, the frequency components of sinusoidal waves at exactly 16.7 Hz are still recorded separately and can be shown with the help of the NFAsoft.

If the filter is set, it is therefore not unusual for the summary indication “All3D” to be smaller than the indication for 16.7 Hz, as the signal components

at 16.7 Hz are not integrated in the total sum of “All3D”. Furthermore, the signals of the different frequencies are added up quadratically, which in turn means that the result of simply adding the individual signals will also differ from the sum of “All3D”. (For more information on this matter see chapter 9).

8 Firmware Update

The file: “firmware.nfa“ is the meter’s operating system stored in its internal memory¹⁷. As known from computer programmes, this software is subject to continuous improvements and upgrade, and can be updated as described below. As also known from computer programmes, a new version of an operating system is always intensely tested prior to distribution, but errors may sometimes occur which are only detected in the course of its use. For this reason, there are always two versions of the firmware on the internal memory of the meter. One is revision 058 which has been running without problems for many years, and should therefore be kept on the meter memory for “emergency cases”, the other is the latest revision at the point of purchase, always with the a.m. risk.

Which firmware is active on your NFA?

If you press the “Mode”-key while switching on the meter, you will for a short while be shown the currently active firmware version (always with either the prefix “F” or “E”. In order to switch from one version to the other, please press both, the “Mode”-key as well as the “Rec.”-key at the same time while switching on the meter.

Procedure for the Update:

First make sure to have firmware version 058 active before starting the update procedure. This way you will always update the other version on your meter.

Copy the new “FIRMWARE.NFA“-file onto your SD memory card without changing it. If need be, overwrite any old versions on the card, as only one “FIRMWARE.NFA“-file should be on the card. It should NOT be renamed. It can be deleted from the card after the update.

Lock your SD memory card with the small switch on the left side of the card. Insert SD card into your powered-off NFA. Switch on your NFA. The display will show “CodE”, the frequency LEDs will gradually change from green to red during the update process. Then all LEDs will turn off except for the status LED. As soon as the status LED turns green, the update process is completed (this will take a few seconds only).

Do not switch the meter off during the update process!

Please remember to unlock the SD-card after applying the new firmware!

Recalibration of the battery capacity display (please see next page: Chapter 9)

¹⁷

Please differentiate: With „NFAsoft“ the firmware can be configured and the user settings stored in the file „CONFIG.NFA“. This has nothing to do with the firmware itself.

9 What if... (FAQ)

Answers to frequently asked questions regarding the NFA1000/NFA400

Make sure to be using the most current firmware version!

The device does not react when trying to switch or press a key

Unlock SD-card! (Push micro switch on the left of the card upwards)

Restart: All switches up – switch off – switch on.

RESET: Switch off meter, open battery compartment, disconnect the two battery plugs, reconnect the batteries after about one minute and switch the meter back on.

Calibration of capacity display after battery change, firmware update, or if the display shows „nBAT“, „00:00“, or an absurd remaining battery capacity reading.

If applicable, disconnect external power supply from the meter. Leave the meter is switched on for a couple of minutes, so that it can recalibrate itself, then switch off and on again. Now the updated remaining battery life in the log mode will be displayed

For a recalibration, leave the meter running (without the AC adapter) until it automatically switches off. Leave to rest for at least one hour. Switch the meter back on until it again automatically switches off after a couple of minutes. Then charge for at least 14 hours. In some cases, the meter needs to be switched off and back on after having been in use for a couple of minutes, before it displays the current running time.

There is no recording (status LED does not turn green)

Insert or unlock SD-card!

(Push micro switch on the left of the card upwards)

No long-term recording over several hours or days possible

Solution 1: Update your firmware.

Solution 2: There is a file system error on your SD-card. In this case, save the “good” files and re-format your SD-card using the original SD-formatter of the SD Association (to be found under the following link: <https://www.sdcard.org/downloads/index.html>).

E-field measurement against ground potential is not possible

The field type switch must be switched to “M3D”. Now you will automatically be shown the E-field vs. ground potential once you insert a grounding cable. Please see the “quick start guide” at the beginning of this manual for further information.

The meter has four measurement channels which always work simultaneously. Three of them are needed for the 3D measurement, the fourth channel can be used for any other required measurement task

The meter turns off after quarter of an hour

NFAsoft allows you to change the interval for the auto-power-off feature. (Auto-power-off is deactivated while recording!)

The sum of the frequency specific channels is higher than the value of “All3D”

The signals of the different frequencies are added up quadratically (square root out of the sum of squares), which means that a simple addition of the individual signals will result in a higher value than the sum of “All3D”.

For example, if you take 500 nT at 16.7 Hz plus 1000 nT at 50 Hz, a simple addition will amount to 1500 nT, whereas the quadratical addition (= “All3D”) will amount to only 1118 nT.

The 16.7 Hz LED is off although measurements with “Band” or “Freq.” show values in this frequency

If the 50 Hz high pass filter has been set with the help of the configuration part of NFAsoft (maybe even as pre-setting), the 16.7 Hz LED will remain unlit. However, the filter only applies to the DISPLAY in the “Auto” mode and to recordings made in the “All3D” channel. The aim is to tranquilize the display. Nevertheless, the device may well identify possible frequency components at 16.7 Hz when using “Band” and “Freq.”.

NFAsoft is showing measurement values at 16.7 Hz in spite of the 50 Hz high pass filter being set and

The sum of the 16.7 Hz channel and the other channels is higher than the value of "All3D"

If the 50 Hz high pass filter has been set with the help of the configuration part of NFAsoft (maybe even as pre-setting), this only applies to the channels "All3D", "AllX", "AllY", and "AllZ".

Nevertheless, possible frequency components at 16.7 Hz will also be recorded in the correspondent channel. In this case the sum of the frequency specific channels may well be higher than that of "All3D".

The NFA was configured according to customer requirements with NFAsoft, but when restarting, NFAsoft shows the original settings

The "CONFIG.NFA" file on the SD-card transfers user-specific configurations to the NFA. NFAsoft can write this file, but not read it. Therefore you cannot use NFAsoft to check the configuration of the NFA, but only to instal new configurations.

You can save frequently used configurations as presets to a dropdown menu in NFAsoft.

What is the purpose of the individual files and where are they saved?

"CONFIG.NFA" -> user configurations of the NFA-> SD-card

"NFAsoft.ini" -> Presettings for NFAsoft -> same folder as NFAsoft

"FIRMWARE.NFA" -> operating system of the NFA -> SD-card

9-Point-Measurement of the electric field ("E3D")...

... in an (almost) field-free area: the indication of the dominant frequency is unpredictable.

In fields of minimal values the indication of the dominant frequency is a matter of pure stochastic

... in an (almost) field-free area we still have a reading on the display

The function "Peak" does not work in combination with "E3D" and a recording (the recording process onto the SD-card causes periodic peaks of 10-20 V/m).

When using a telescopic rod, a reading may well be caused by either movement-induced fields or alternating electrostatic fields from your contact with the rod.

Solution: The configuration part of NFAssoft allows to set the high pass filter at 16 Hz or 50 Hz. This will suppress most of these "pseudo fields", the 50 Hz filter of course more so than the 16 Hz filter. In areas where the 16.7 Hz frequency is not used for traction power you should choose the 50 Hz filter.

->

... in an (almost) field-free area and using the equipment holder PM1 the evaluation with NFAssoft still shows high values at usually only one point, especially in the "R<2k" channel which does not usually show up during a "normal" measurement

This is nearly always a matter of "pseudo fields" caused by movements or electrostatics in the area of the meter (for instance by the person moving away from the measurement device). Please check chapter 5.2 for more details on the conduction of a proper measurement avoiding this effect.

These pseudo-readings can, if need be, be deleted from the graph by opening the 9PM-file with a text editor and replacing the odd value by "0.0".

The grounding cable plug slips out of the jack, or there is a loose connection

The plug is inserted too far into the isolating material, so there is no connection

Solution: Hold on to the middle part of the contact on the plug with a tong, and screw back the isolation material



WRONG



Correct

Lint, streaks or “scratches” on the display?

In order to assure a high resolution potential free measurement of the E-field, a relatively sensitive metal foil has had to be mounted onto the display itself. Unfortunately, lints, scratches or streaks cannot be completely avoided. But - as the saying goes - enough is enough. Should this be the case with your meter, please send it in. We will replace the foil free of charge.

There are very many small TXT-files on the SD-card?

Solution 1: You have activated the function “permanent logging”, which causes the meter to log not only when switched to “Log”. This option will cause a new file to be started and saved each time the meter is switched on, and each time you switch from one mode to the other.

Solution 2: There is a file system error on your SD-card. In this case, save the “good” files and re-format your SD-card using the original SD-formatter of the SD Association (<https://www.sdcard.org/downloads/index.html>).

An existing audio note it is not shown in the diagram window of NFAsoft.

The audio files (.wav) will only be displayed in the diagram if they are stored in the same folder as the LOG-file and if they are not renamed.

Hersteller / Manufacturer

Gigahertz Solutions GmbH
Am Galgenberg 12
90579 Langenzenn

Germany

Tel : +49 (9101) 9093-0

Fax : +49 (9101) 9093-23

www.gigahertz-solutions.de / www.gigahertz-solutions.com

Ihr Partner vor Ort / Your local partner